

For detailed instructions, please refer to the Uninet iColor 800W Printer User Manual and the Uninet iColor ProRIP User Manual

1. Remove the packing materials and check the components

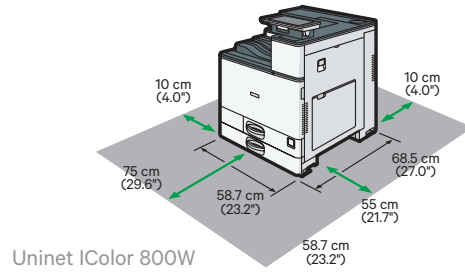

2. Remove orange tape

- From all sides

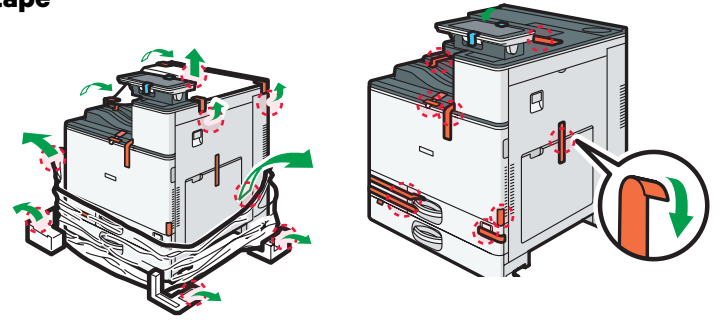

3. Remove orange security tape and lock from inside printer



4. Connect the printer power cord and turn on.

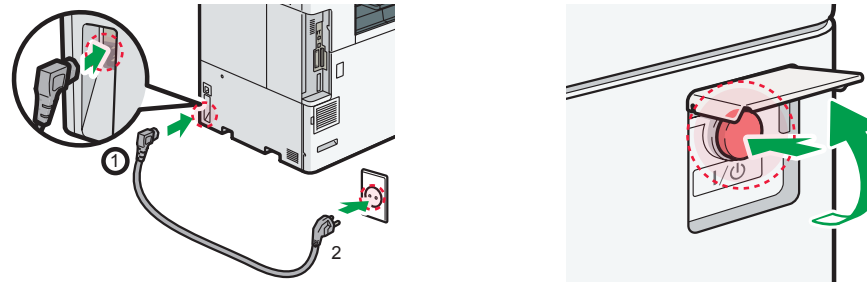

5. The Uninet iColor 800W Digital Color + White Transfer Media Printer has one configuration

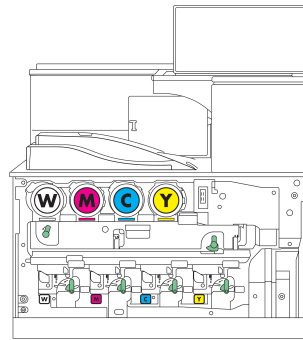

Printer Display Reads	Replace with
Cyan low/out/empty	Cyan
Magenta low/out/empty	Magenta
Yellow low/out/empty	White
Black low/out/empty	Yellow



Replace with UniNet OEM supplies only!
Incompatible supplies will damage the printer.

6. Install the Uninet iColor ProRIP (stored on the provided dongle)

- Choose your language and follow the install steps

Please disable/uninstall any Anti Virus software before installation of the UniNet ProRIP

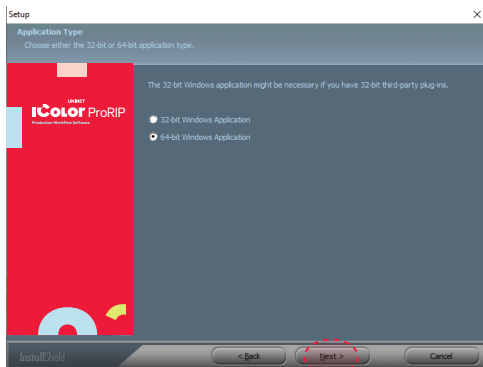

SetUp
Application Type. Choose either 32-bit or 64-bit application type. To Continue, select Next.

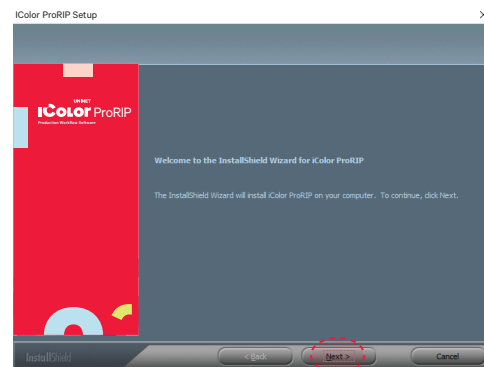

iColor ProRIP Setup
InstallShield Wizard for iColor ProRIP
The InstallShield Wizard will install iColor ProRIP on your computer. To Continue, select Next.

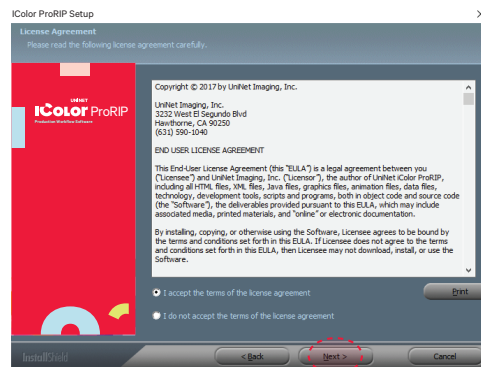

iColor ProRIP Setup
License Agreement
Please read the following license agreement carefully. If you agree, Accept and select Next.

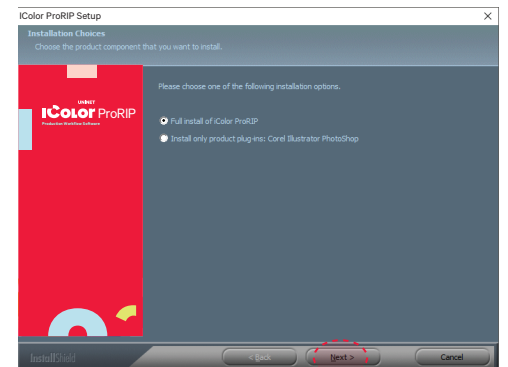

iColor ProRIP Setup
Installation Choices
Choose 'Full install of iColor ProRIP' and select Next.

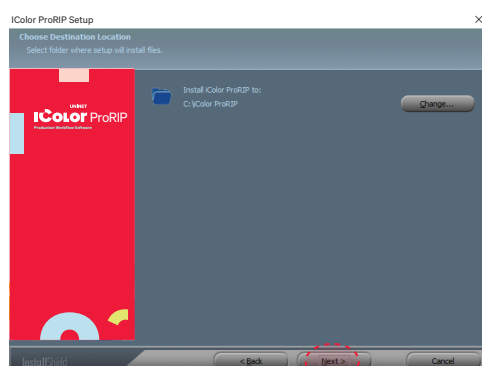

iColor ProRIP setup
Choose Destination Location. Select folder where setup will install files. To Continue, select Next.

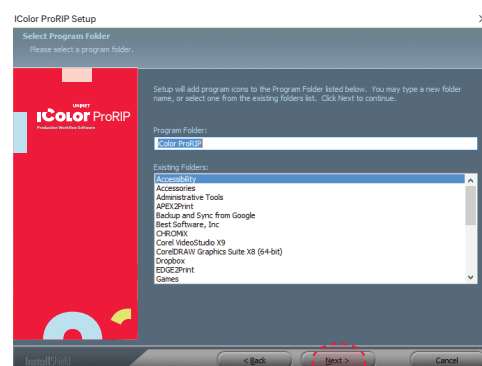

iColor ProRIP setup
Select Program Folder. Please select a program folder. Setup will add program icons to the Program Folder listed below. You may type a new folder name, or select one from the existing folders list. Select Next to continue.

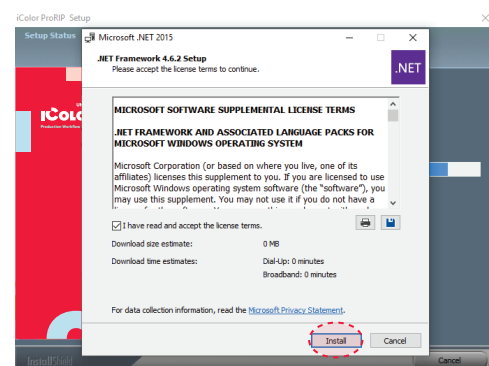

iColor ProRIP Setup
Agree to license terms and select Install.

7. Uninet IColor ProRIP software

First time Setup

- Ensure the ProRIP dongle is inserted and you are connected to the internet (required)
- Launch the software
- Set unit of measure and decimal places, then select OK.

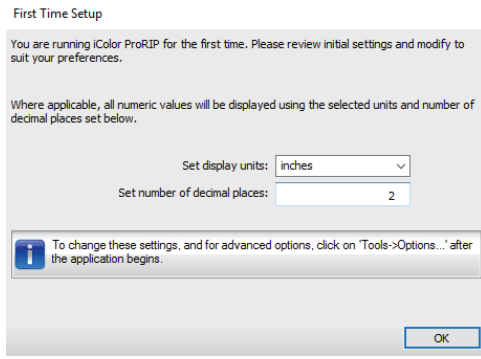

9. ProRIP opens, the Queue Wizard will begin the installation of the support files for your IColor 800 printer

- Select next

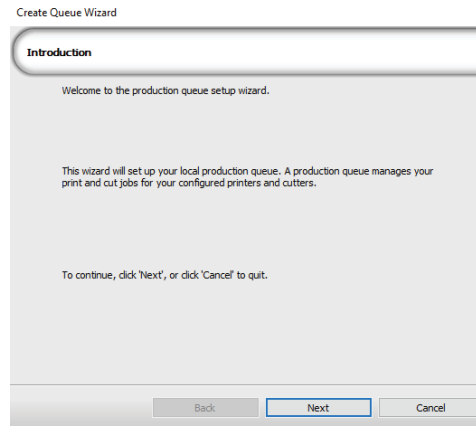

- Select Install Printer

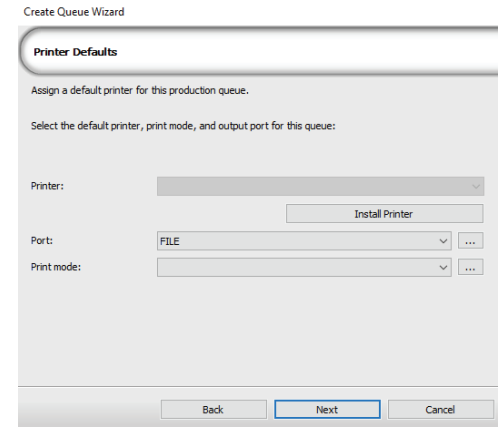

10. Select the IColor 800 printer from the support menu and select 'OK'

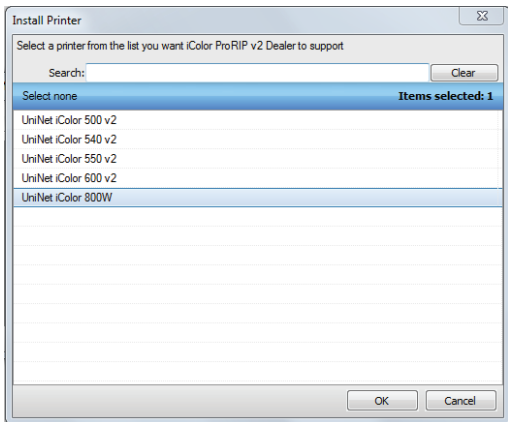

11. Device package search

- Select 'Search' for new printer package
- Select 'Next' to continue the installation

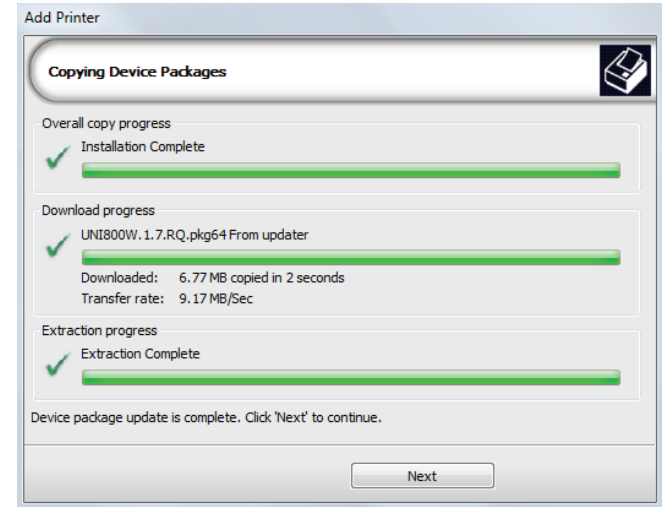
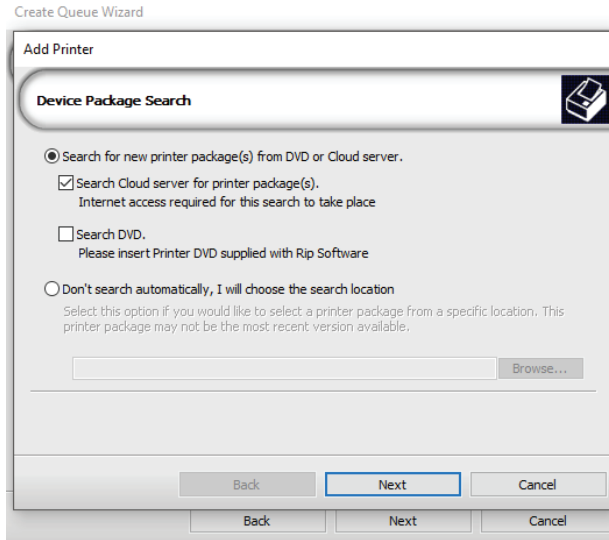

12. Select 'Finish' to complete the installation

- Please continue for software configuration

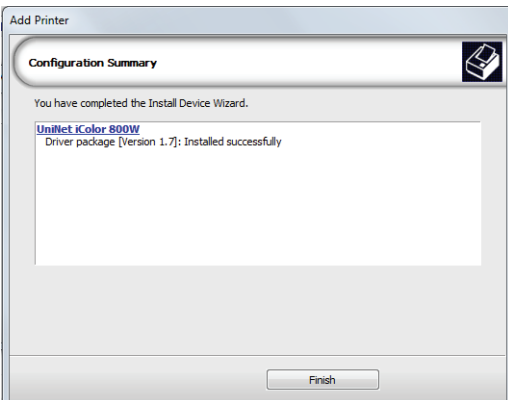

13. Uninet IColor ProRIP printer queue setup

- Open the IColor ProRIP
- Select Queue/Manage Queues
- Select the proper port from the 'Port' drop down menu.
- If connected via network (recommended), choose TCP/IP.

- If connected by USB, choose the printer as identified in the drop down
- * All other ports will update automatically, it is only necessary to do this for one queue
- Select 'Close'

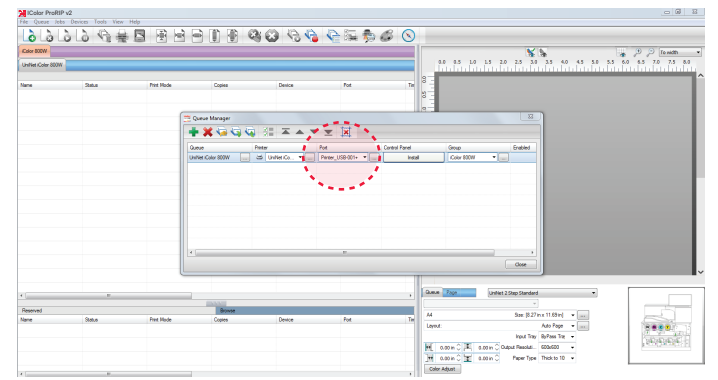
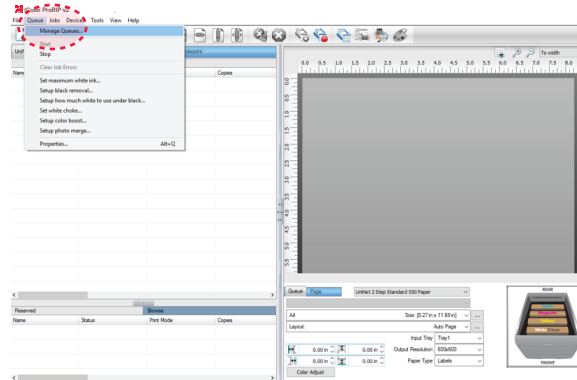

14. Select the proper Print Queue for your project

A. Select your 'Print Que' and 'Print Mode'

- The 'Print Modes' have preset values for white coverage, choke, paper size, paper tray and mirror settings

These can be modified as needed

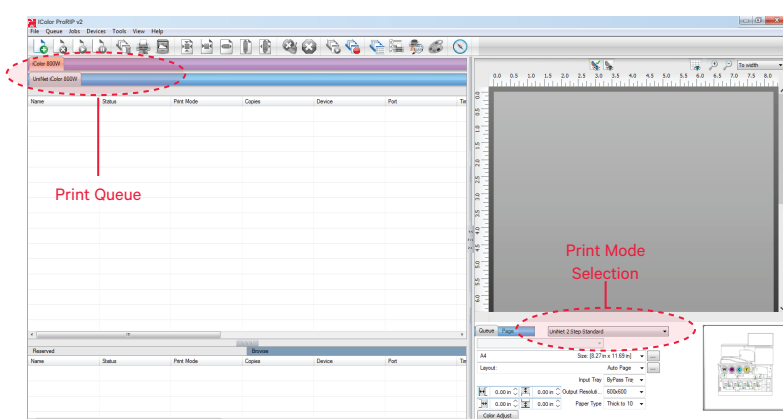

15. Import + print graphic

A. Three ways to import graphics

- 1. Select the 'green plus' icon and navigating to the proper folder.
- 2. Select File > Import File
- 3. Simply dragging and dropping your file into the queue

B. Select the desired file

- C. Select 'Print' icon in the menu bar.

